

INSTRUCTION

for

EMCO Orifice plate for insertion between orifice flanges

type ISB/1

Liquid, gas, and steam

Application

EMCO orifice plate for insertion between orifice flanges is the primary element in liquid, gas or steam flow measurement according to the differential pressure principle.

The fluid must be in one phase and the pipe shall run full in the measuring section.

Changes of flow shall be slowly i.e. without pulsation's.

Storage

Before installation the primary element must be kept clean and protected against corrosion and physical damage.

Careful attention to the sharp edge of the orifice plate is important.

Pipe Run

The EMCO orifice plate is fitted between 2 orifice flanges which form part of the straight cylindrical pipe of constant cross-sectional area without any obstructions. The inner pipe diameter D must not vary more than 0,3% of D used in the bore calculation.

The required minimum straight lengths of pipe vary according to beta and the nature of obstruction - bends, reducers etc.

From the table below it can be seen how many times the inner pipe diameter D is required for "zero additional uncertainty".

The values in the brackets give "+/-0,5% additional uncertainty". These are applicable when the length of the straight pipe run is between the unbracket and the bracket values.

If the straight lengths are shorter than the bracketed values no information is available of the value of any further uncertainty.

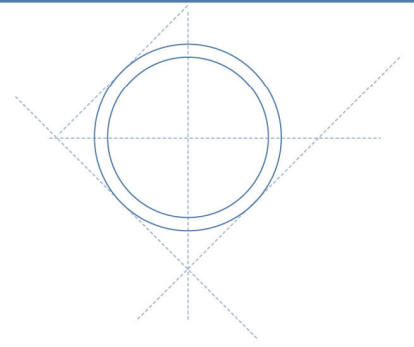

β	On upstream (inlet) side of the primary device							On downstream (outlet) side
	Single 90° bend or tee (flow from one branch only)	Two or more 90° bends in the same plane	Two or more 90° bends in different planes	Reducer (2 D to D over a length of 1,5 D to 3 D)	Expander (0,5 D to D over a length of 1 D to 2 D)	Globe valve fully open	Gate valve fully open	All fittings included in this table
≤ 0,20	10 (6)	14 (7)	34 (17)	5	16 (8)	18 (9)	12 (6)	4 (2)
0,25	10 (6)	14 (7)	34 (17)	5	16 (8)	18 (9)	12 (6)	4 (2)
0,30	10 (6)	16 (8)	34 (17)	5	16 (8)	18 (9)	12 (6)	5 (2,5)
0,35	12 (6)	16 (8)	36 (18)	5	16 (8)	18 (9)	12 (6)	5 (2,5)
0,40	14 (7)	18 (9)	36 (18)	5	16 (8)	20 (10)	12 (6)	6 (3)
0,45	14 (7)	18 (9)	38 (19)	5	17 (9)	20 (10)	12 (6)	6 (3)
0,50	14 (7)	20 (10)	40 (20)	6 (5)	18 (9)	22 (11)	12 (6)	6 (3)
0,55	16 (8)	22 (11)	44 (22)	8 (5)	20 (10)	24 (12)	14 (7)	6 (3)
0,60	18 (9)	26 (13)	48 (24)	9 (5)	22 (11)	26 (13)	14 (7)	7 (3,5)
0,65	22 (11)	32 (16)	54 (27)	11 (6)	25 (13)	28 (14)	16 (8)	7 (3,5)
0,70	28 (14)	36 (18)	62 (31)	14 (7)	30 (15)	32 (16)	20 (10)	7 (3,5)
0,75	36 (18)	42 (21)	70 (35)	22 (11)	38 (19)	36 (18)	24 (12)	8 (4)
0,80	46 (23)	50 (25)	80 (40)	30 (15)	54 (27)	44 (22)	30 (15)	8 (4)

For all β values	Fittings	Minimum upstream (inlet) straight length required
	Abrupt symmetrical reduction having a diameter ratio $\geq 0,5$	30 (15)
	Thermometer pocket or well of diameter $\leq 0,03 D$ Thermometer pocket or well of diameter between $0,03 D$ and $0,13 D$	5 (3) 20 (10)

It is recommended to use full bore valves upstream the primary element. The valves shall be fully open.

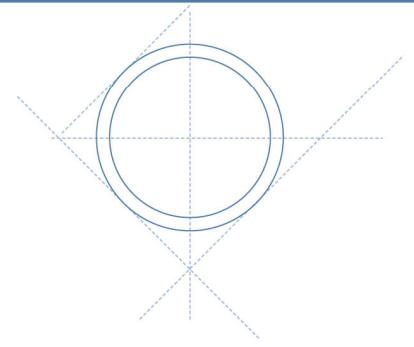

The inside surface of the measuring pipe shall be clean, free from pitting and deposit for at least a length of 10 times D upstream and 4 times D downstream of the orifice plate. The inner roughness shall be below the limits given in the table below.

Upper limits of relative roughness of the upstream pipe-line for orifice plates

β	$\leq 0,3$	0,32	0,34	0,36	0,38	0,4	0,45	0,5	0,6	0,7	0,8
Corner taps $10^4 k/D$	25	18,1	12,9	10,0	8,3	7,1	5,6	4,9	4,2	4,0	3,9
Flange taps and D and $D/2$ taps $10^4 k/D$	25	18,1	12,9	10	10	10	10	10	10	10	10

Typical inner pipe wall roughnesses are stated below.

Examples of values of the pipe well roughness k

Material	Condition	k , mm
brass, copper, aluminium, plastics, glass	smooth, without sediments	< 0,03
steel	new, seamless cold drawn	< 0,03
	new, seamless hot drawn	< 0,03
	new, seamless rolled	0,05 to 0,10
	new, welded longitudinally	0,05 to 0,10
	new, welded spirally	0,10
	slightly rusted	0,10 to 0,20
	rusty	0,20 to 0,30
	encrusted	0,50 to 2
	with heavy incrustations	> 2
cast iron	bituminized, new	0,03 to 0,05
	bituminized, normal	0,10 to 0,20
	galvanised	0,13
	new	0,25
asbestos cement	rusty	1,0 to 1,5
	encrusted	> 1,5
	bituminized, new	0,03 to 0,05
asbestos cement	insulated and not insulated, new	< 0,03
	not insulated, normal	0,05

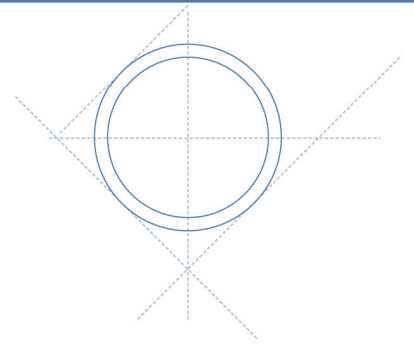

Installation

The EMCO orifice plate must be centred carefully in the pipe line.

Steam and gas

When the primary element is installed in a horizontal pipe measuring a flow which tends to condensate the orifice plate is provided with a drain hole to let the liquid pass the orifice plate. The drain hole must be at the bottom of the pipe.

Liquid

If a liquid in a flow measurement tends to form a gas the orifice plate is provided with a vent hole to let the gas pass the orifice plate.

The vent hole must be in the top of the orifice plate.

When the orifice flanges for the primary element are welded into the pipe line an approved method of welding and if necessary heat treatment must be used.

In case of a bevelled orifice plate the bevelled side is the downstream side.

Flange gaskets must suit the fluid and the service conditions.

The inner diameter of the flange gaskets must be greater than the inner pipe diameter. It is advised that the outer diameter of the gaskets is equal to the diameter of the bolt circle minus the diameter of a bolt.

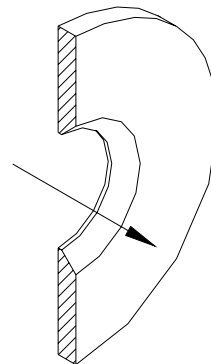

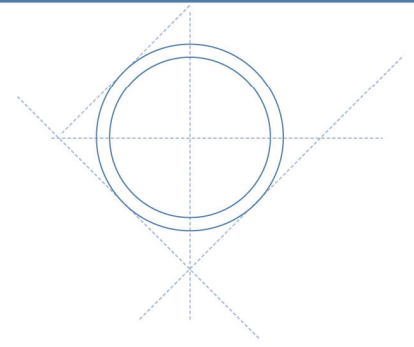

Tap location

2 pressure tapings are provided in each flange, one set for flow measurement the other for venting or drainage.

Liquid

In a horizontal pipe the pressure taps shall be in the horizontal pipe axis or better below.

Gas

In a horizontal pipe the pressure taps shall be in the horizontal pipe axis or better above.

Steam

The orientation of the pressure taps is matched to either a vertical or horizontal pipe run. It is recommended to use condensing chambers and it is important that the 2 condensing chambers are at the same level to ensure equal water column above the differential pressure transmitter

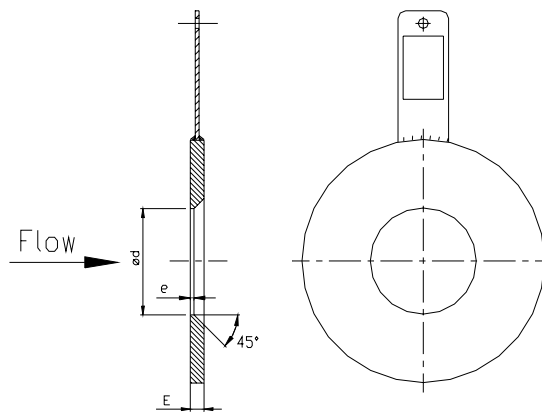

Instrument Connection

It is recommended to install the differential pressure transmitter below the orifice plate. The " + " side of the orifice plate is connected to the " + " side of the differential pressure transmitter and the two " - " sides are connected.

The impulse lines must be installed with a slope to let captured air escape.

The impulse lines should not be less 12 x 2 mm in a material suitable to the service condition.

It is recommended to use primary isolating valves with the orifice flanges.

It is also recommended to use a 5-way manifold valve in connection with the differential pressure transmitter in order to isolate, equalise and blow-down or depressurise the transmitter.

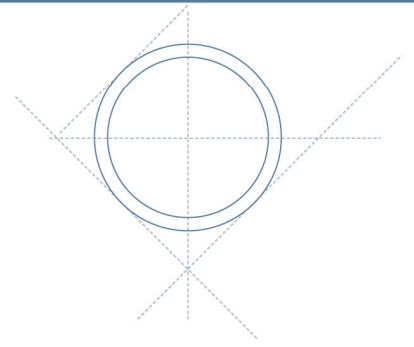

Safety

The pipe system, in which the orifice plate will be part of, must be equipped with a safety device, ensuring that the maximum allowable pressure is not exceeded. The orifice plate is not supplied with any safety devices and must not be used for higher pressure, than stated on the name plate.

During operation the outer surface of the unit will reach nearly the same temperature as the operating fluid. Hence it is recommended, at elevated temperatures, to insulate the pipe or ensure that the pipe is inaccessible during operation.

Exposing the orifice plate to elevated temperatures may weaken the material. Therefore the plate must not be exposed to higher temperatures, than stated on the name plate.

Maintenance

The EMCO orifice plate requires no special maintenance. It is however important that the sharp edge of the orifice remains sharp and that the orifice plate, the orifice flanges and the mating pipe are free from deposits.

References

ISO 5167, DIN 19206, ISA-RP 3.2, Shell Flow Meter Engineering Handbook, L.K. Spink and AGA no. 3.